

ARENA MEDIUM

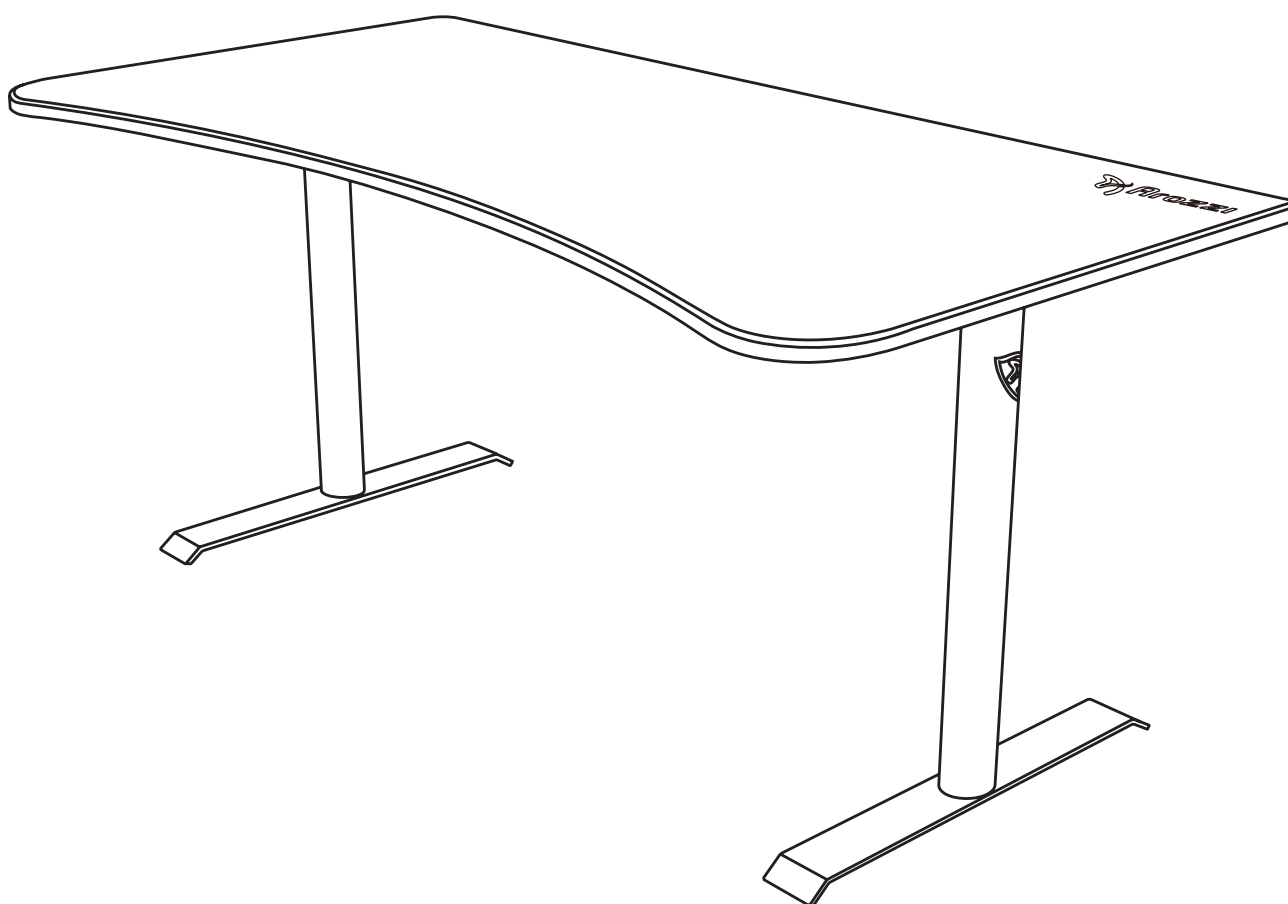

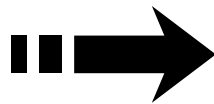

youtube.com/@ArozziSupport

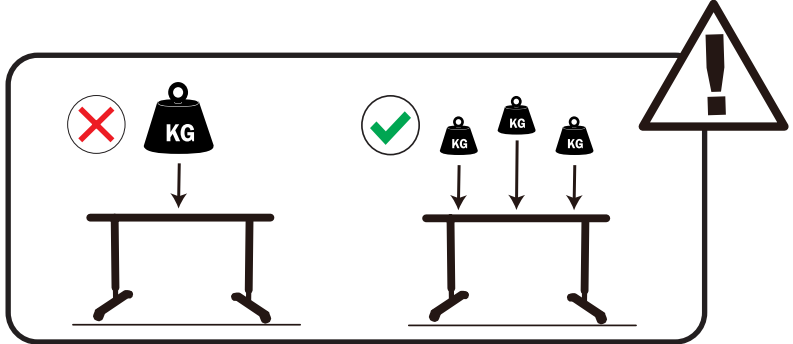

EU: arozzi.se/support/
US: arozzi.com/support/
Elsewhere: arozzi.se/support/

A



x 8

B

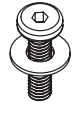

x 16

C

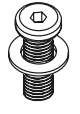

x 8

D

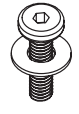

x 14

E



x 8

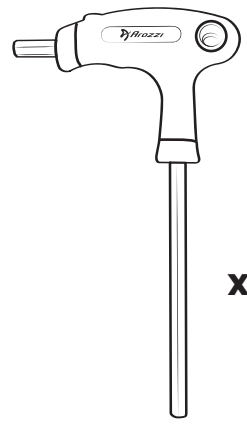

x 1

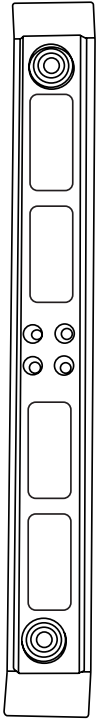

x 2

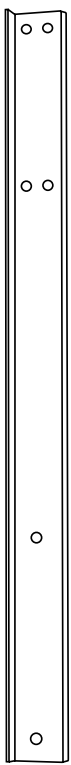

x 2

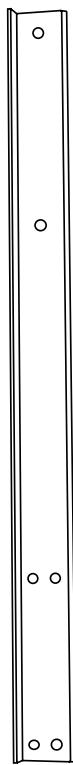

x 2

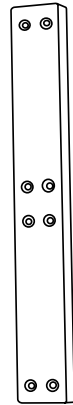

x 2

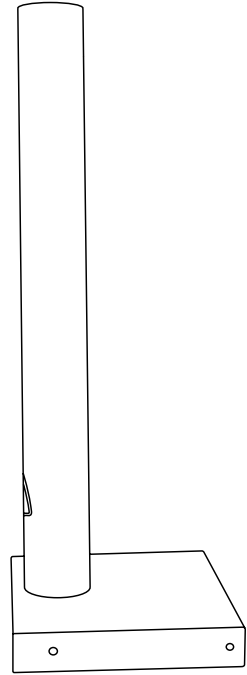

x 2

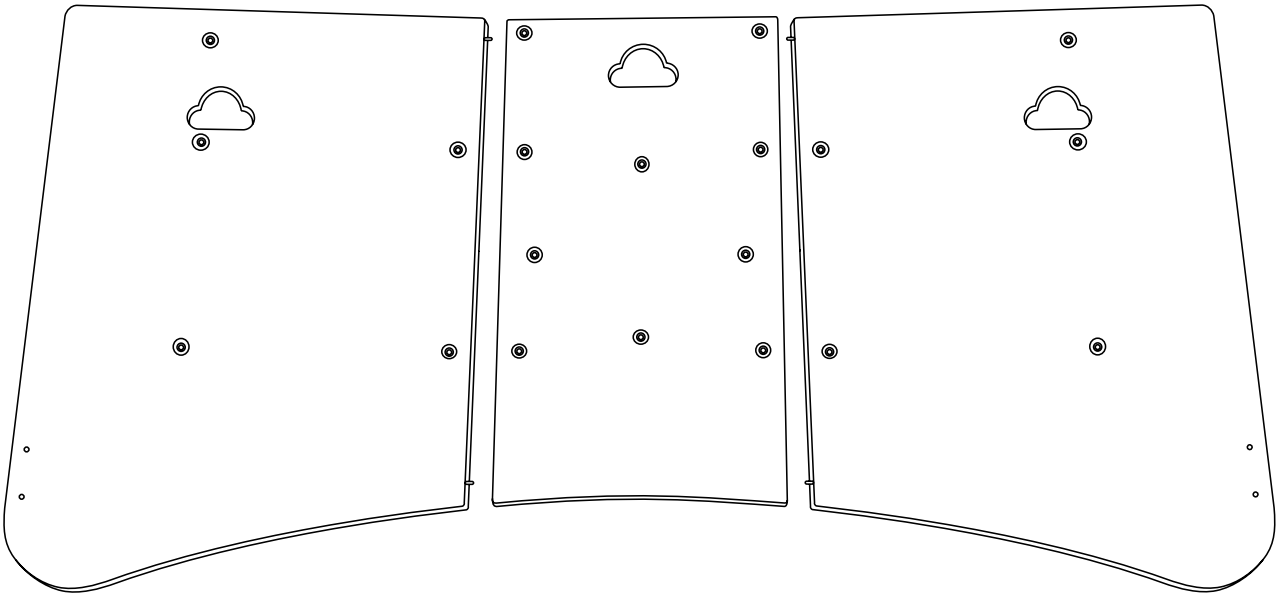

1

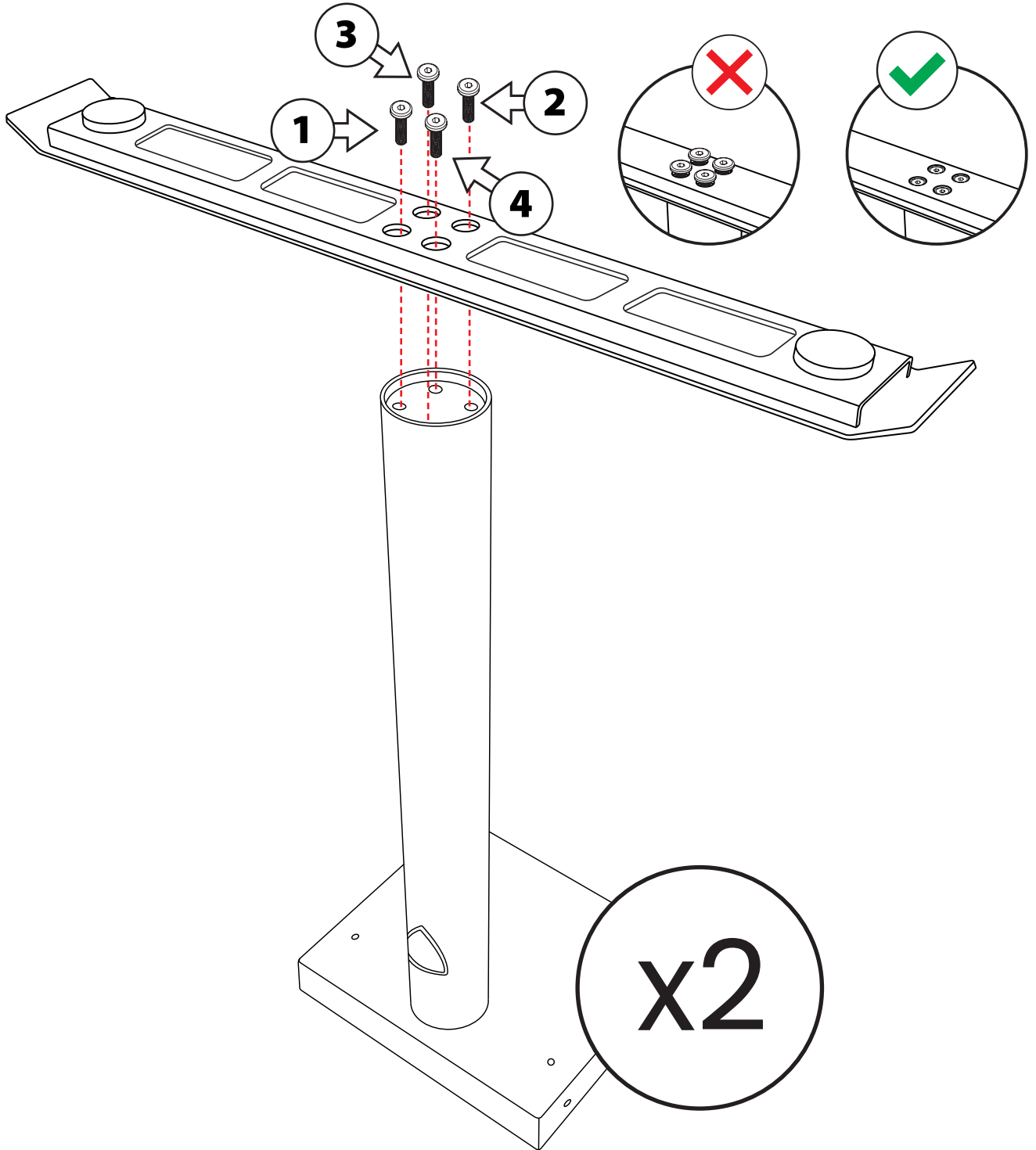
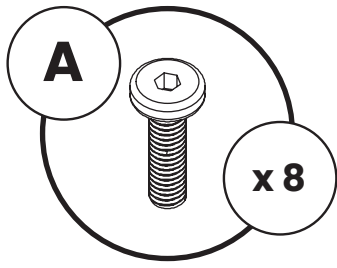

Repeat in order 1 to 4 until all screws are tight

2

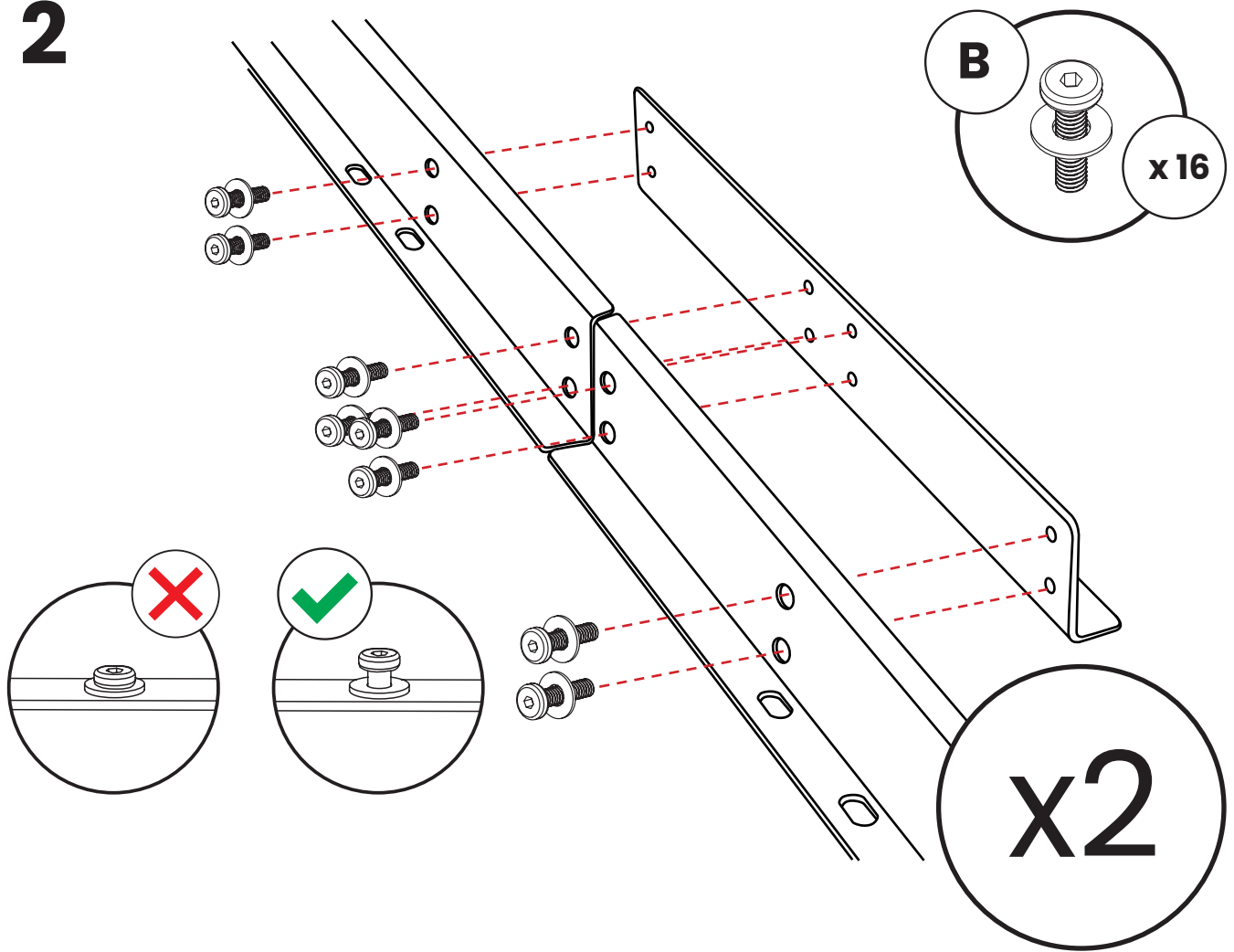

3

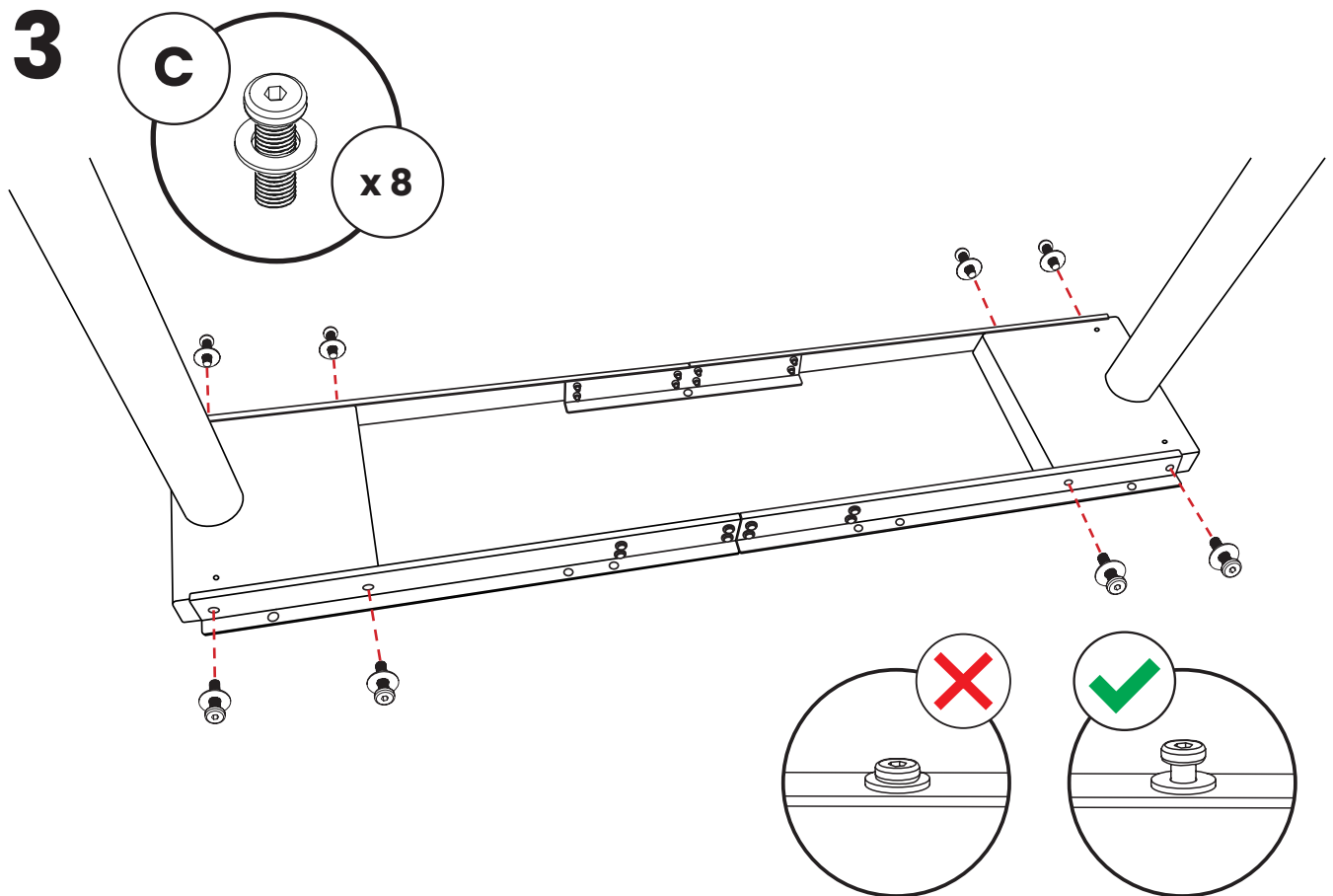

4

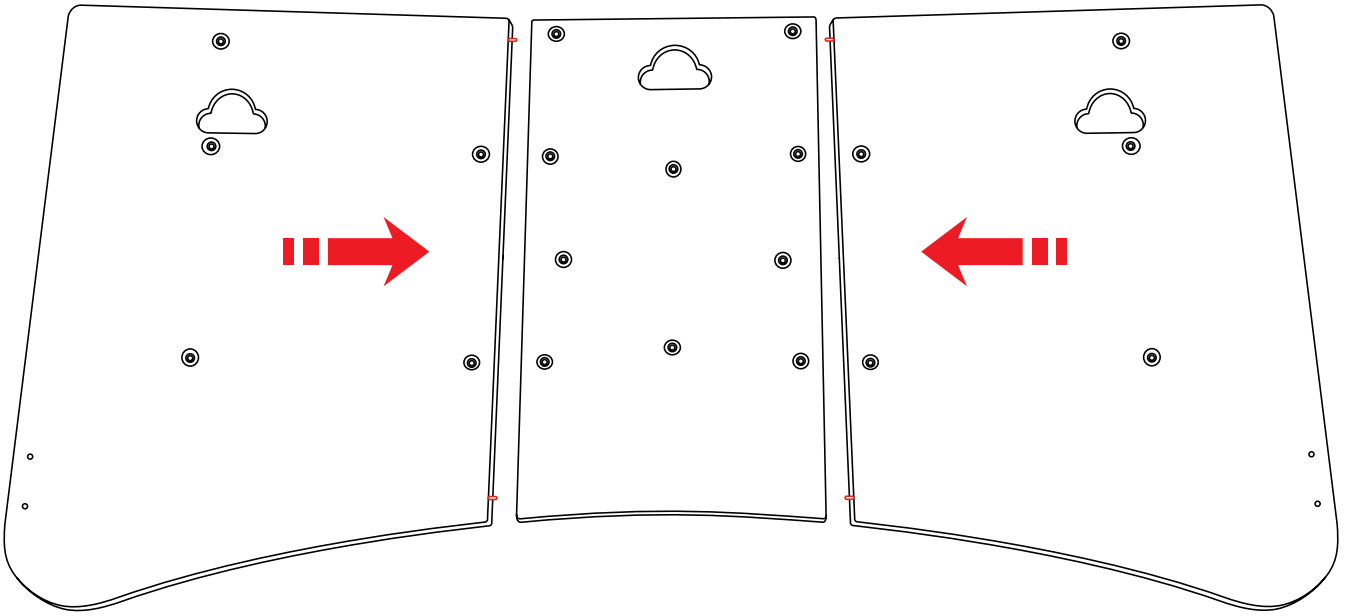

5

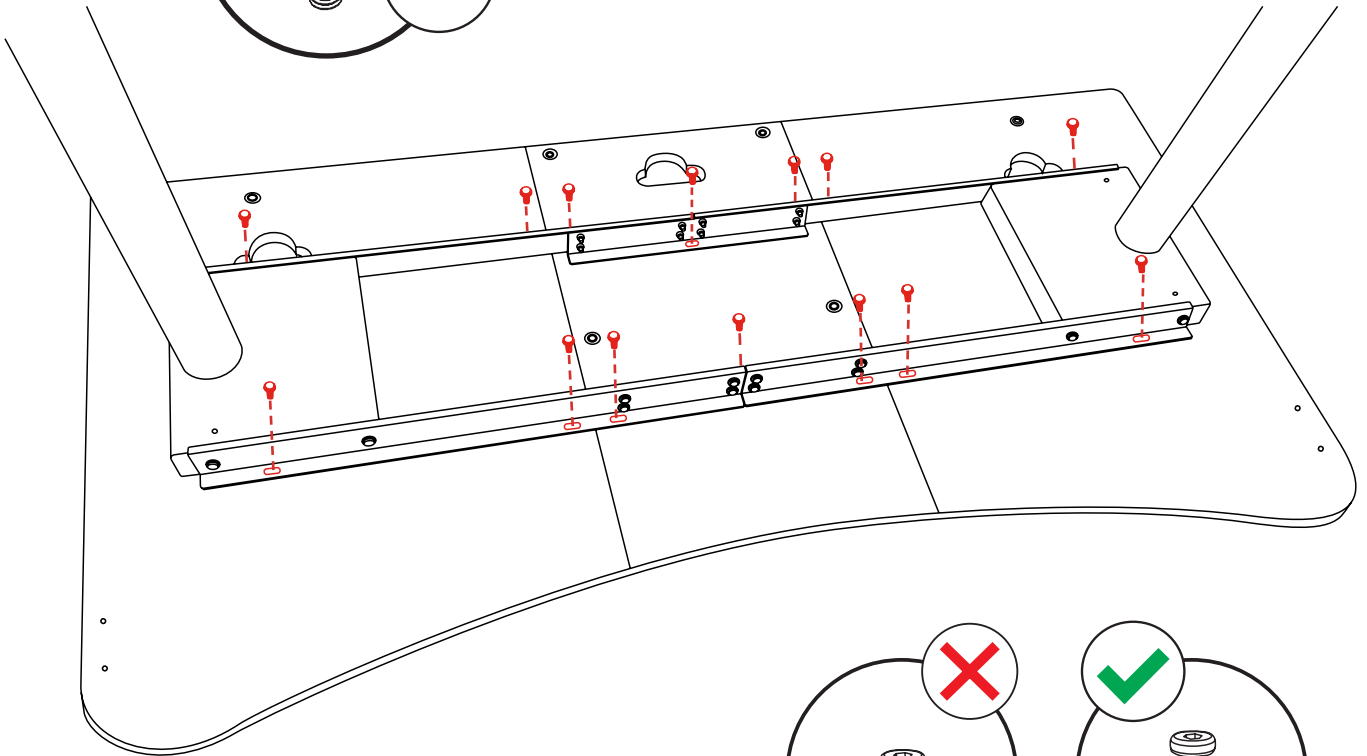
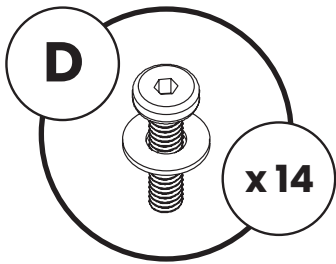

6

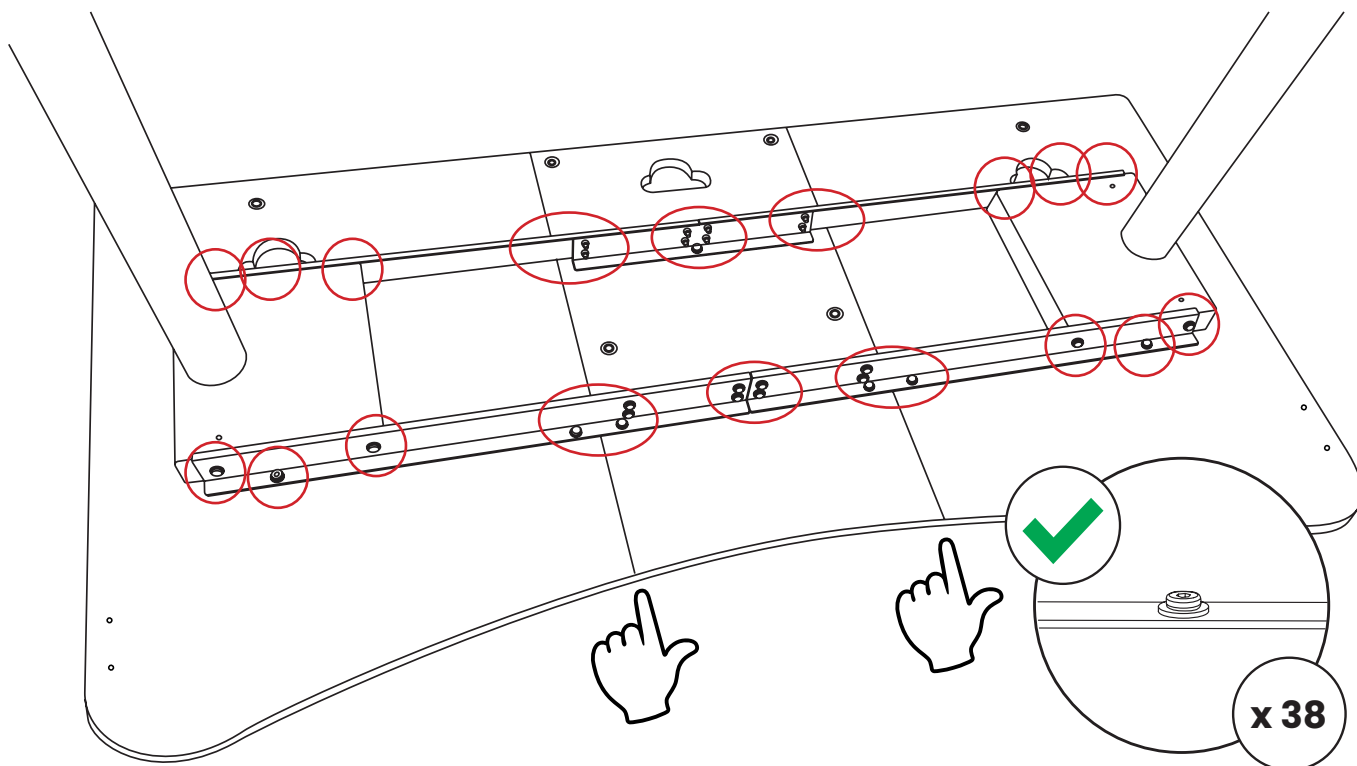

! Before tightening the screws, make sure that the table top panels are flush against each other.

7

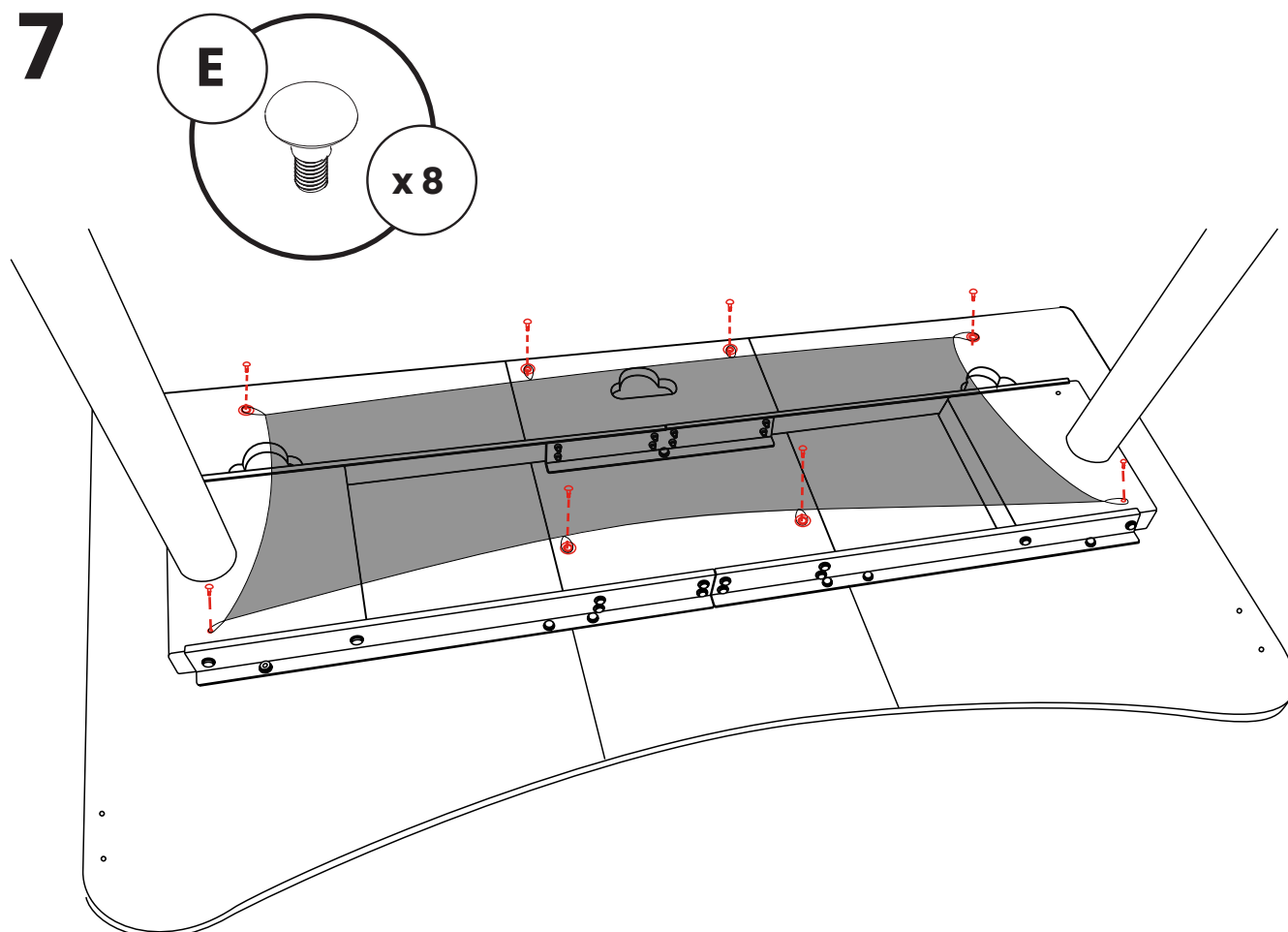

8

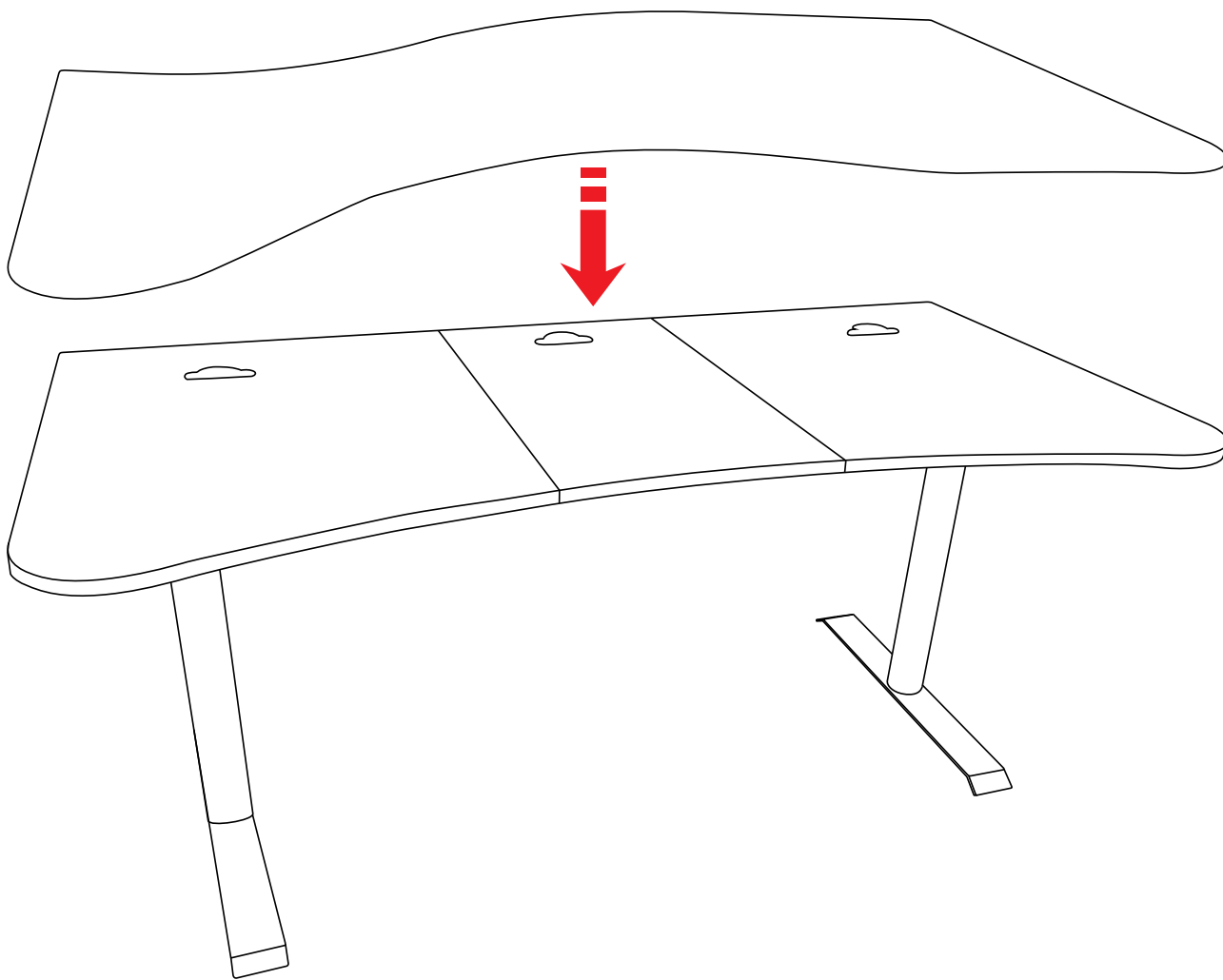

9

